



CEIA THS/PH210®

PHARMACEUTICAL & NUTRACEUTICAL METAL DETECTION SYSTEMS

+39 0575 4181 • pharma@ceia-spa.com
w w w . c e i a . n e t



Quality Control at its finest

CEIA THS/PH21[®] and THS/PH210[®] Metal Detection Systems offer design, construction and reliability characteristics that make them the most effective solution for the automatic elimination of metal contaminants.

FDA 21 PART 11 COMPLIANCE

FDA Code Title 21 Part 11 prescribes rigorous criteria for access to programming and computer data protection, which have been fully adopted in the CEIA THS/PH21[®] and THS/PH210[®] Series firmware. User access is only possible via a User Name and Password login under the control of the System Administrator, who programs and manages individual user profiles and user functions. As a result, the requirements for security, integrity and traceability are fulfilled.

All events relevant to the THS/PH21[®] and THS/PH210[®] Metal Detectors are recorded in a data log to comply with FDA Part 11 protocol and assist in root cause analysis. **The events include detection, ejection, program operations, passwords and calibration tests using standard test samples or the AUTO-QC function.** A proprietary checksum algorithm ensures data integrity and prevents any tampering of the logged data records.

FDA 21 CFR 210 COMPLIANCE

The regulations set forth in 21 CFR 210 FDA Standard concern the good manufacturing practice, the methods and the controls to be used for the manufacture, processing, packing, or holding of a drug to assure that such drug meets the requirements of the act as to safety and meets the quality and purity characteristics that it purports or is represented to possess.

The THS/PH21[®] and THS/PH210[®] Metal Detector Series are high-sensitivity, high-precision, measuring instruments. The output from the devices directly drives the ejection of the contaminated products while dedicated sensors perform closed-loop verification that they have in fact been eliminated.

In terms of detection of metal contaminants and confinement of the contaminated drugs, **CEIA THS/PH21[®] and THS/PH210[®] are state-of-the-art solutions with high and consistent performances in time and automatic compensation** of all thermal, mechanical and electromagnetic environmental changes.

Validation Solutions Available:

- ✓ Calibration Standards
- ✓ Validation Manuals
- ✓ Comprehensive Service & Support
- ✓ Compliance Tools
- ✓ On-line Production Data Validation



These systems are compliant with the applicable parts of the 21 PART 11 and 21 CFR 210 FDA Standards and deliver advanced control features and extremely high detection sensitivity for metal contaminants - whether ferrous, non-ferrous, or stainless steel - on pharmaceutical products such as powders, capsules, tablets, and liquids.

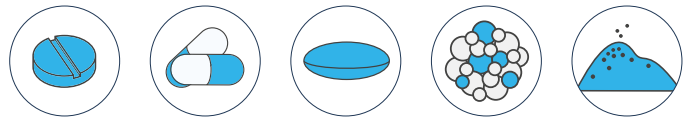

COMPLIANCE EXCEEDING THE QUALITY STANDARDS

To comply with and exceed the current pharmaceutical Quality Standards CEIA THS 21[®] and 210[®] Metal Detector Series provide:

- ✓ **A fully digital internal structure**, free from trimmers to be calibrated, as analog processing has been completely replaced by digital numerical processing;
- ✓ An automatic, wide dynamic, antenna balance tracking system to maintain in-range performances in all installation environments;
- ✓ **A continuous auto-diagnostic system**, signalling detected faults in a fraction of a second;
- ✓ **A continuous embedded AUTOTEST** function to lock performances stability and consistency;
- ✓ An **AUTO-QC** function for the automatic verification of the calibration;
- ✓ A full FDA Code 21 Part 11 compliant Data Recording and Traceability capability

CONTINUOUS AUTOTEST FUNCTION

Calibrated reference signals are continuously injected into the transmission and reception chain of the THS/PH21[®] and THS/PH210[®] Series Metal Detector, generating corresponding multi-spectrum amplitude and phase changes which are compared with the reference values stored in the memory of the Metal Detector at the time of the FAT (factory acceptance test).

This internal function allows to correct any drift of the emission/reception chain in real-time, providing maximum repeatability and performance consistency over time and with environmental changes. The final result for the User is system stability and consistency in detection performance and product effect neutralization.

AUTO-QC FUNCTION

The AUTO-QC function generates automatic stimuli corresponding to the manual metal samples transits, verifying the correct activation of the alarm and of the ejector. The mix of manual and automatic test operations can be programmed in a wide ratio range (from full manual up to one manual to full automatic), depending on the User Quality procedures.

EXCLUSIVE AUTO-LEARN SYSTEM

The Multi-Point Auto-Learn System provides simultaneous maximum sensitivity to all metals starting from a single learning transit. The THS/PH21[®] and THS/PH210[®] Series employ an exclusive Auto-Learn system for pharmaceutical products, which allows optimization of the detection sensitivity to all metals with the maximum speed and precision, equivalent to hundreds of conventional learning transits. This results in levels of precision and efficiency never before obtained.

ISO 9001 COMPLIANCE

CEIA THS/PH21[®] and THS/PH210[®] Metal Detection Systems are manufactured under **CEIA ISO 9001 Certified Quality Management System**, ensuring consistent delivery of products and services that meet Customers and Regulatory requirements.

THS/PH21[®] & THS/PH210[®] PRODUCTIVITY AND COST SAVINGS

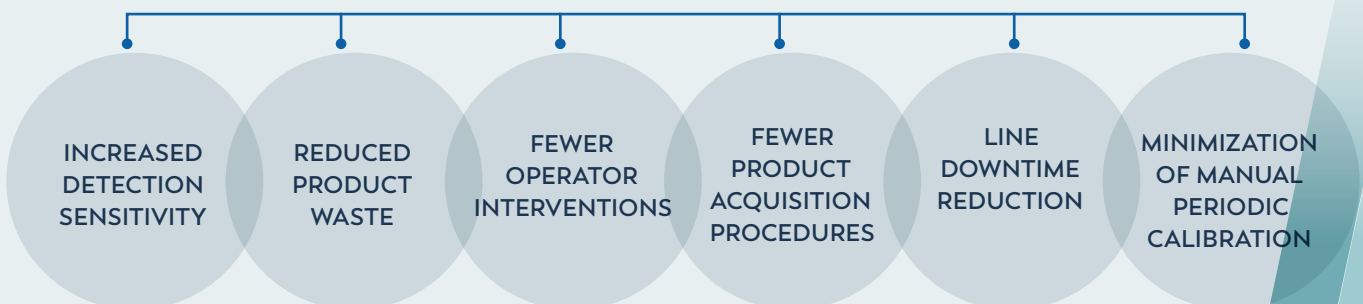

THS/PH210®

COMPLIANCE EXCEEDING THE QUALITY STANDARDS

NEW

KEY FEATURES

- **EXTREMELY HIGH PERFORMANCES:**
+50% sensitivity in terms of detectable metal volume*
- **BEST PRODUCT THROUGHPUT RATE**
- **FULL AISI 316L** Stainless Steel construction
- **FULLY DIGITAL INTERNAL ELECTRONIC STRUCTURE**
- **AUTOTEST** Function
- **AUTO-QC** Function
- **MULTI-POINT AUTOLEARN** System
- **500 PRODUCT PROFILES**, selectable by local programming or network software
- **EMBEDDED NETWORK CONTROLLER** and **DATA LOGGER PC**, insulating the internal firmware from the network

* Average value on FE, nFE, ST-ST METAL contaminants Vs THS/PH21N



**DUST TIGHT & WIP
VERSIONS AVAILABLE:**

- ✓ THS/PH210-DT
- ✓ THS/PH210-WIP



KEY FEATURES

- **FDA CODE 21 PART 11 COMPLIANT** data recording and traceability capability with **1,000,000 storable events** and data integrity verification
- **OPTIONAL EMBEDDED FIELD-BUS CONTROLLER FOR OEM SYSTEM INTEGRATION**
(selectable among EtherNet/IP, Profinet, Profibus, Ethercat, ModBus/TCP, Profinet-OPC-UA)
- **MAXIMUM CONFIGURABILITY / INTEGRATION**
- **RAPID CLEANABILITY**
- **HIGH MANOEUVRABILITY** thanks to four large diameter, lockable, swivelling casters
- **CONTROL POWER BOX** available according to **UL 508A** and **CSA-C22.2** No. 286
- **LEVEL SENSOR ON REJECT BIN** (optional) with indication of bin almost full, bin full and bin absent



HIGH VISIBILITY SWIVELLING HMI with large (7") colour display and extremely robust capacitive touch screen



HIGH MANOEUVRABILITY thanks to four large diameter, lockable, swivelling casters



- **EASY PROBE POSITION ADJUSTMENT** allowing change of height, width and angle tilt in seconds



HIGH PERFORMANCE PHARMACEUTICAL METAL DETECTION SYSTEMS

THS/PH21[®]N

ULTRA HIGH SENSITIVITY METAL DETECTOR

- Ultra high sensitivity to all magnetic and non-magnetic metals, including stainless steel
- AISI 316L stainless steel construction
- Control Power Box available according to UL 508A and CSA-C22.2 No. 286 
- 500 product profiles, selectable by local programming or network software
- 10,000 storable events
- High-contrast OLED graphic display
- Local programming: 16 stainless steel keys, 3 with double function
- Quick Access key for fast programming of user parameters
- AUTOTEST function
- AUTO-QC function





THS/PH21N model

THS/PH21[®]ET

HIGH SENSITIVITY METAL DETECTOR

- High sensitivity to all magnetic and non-magnetic metals, including stainless steel
- AISI 316L stainless steel construction
- Control Power Box available according to UL 508A and CSA-C22.2 No. 286 
- 250 product profiles, selectable by local programming or network software
- 1,000 storable events
- 4 x 20 character OLED alphanumeric display
- Local programming: 4 stainless steel keys, 3 with double function
- AUTOTEST function
- AUTO-QC function

PRODUCT		VERIFIED THROUGHPUT (items / h)
		THS/PH21N - THS/PH21E (100 mm x 40 mm)
	19 mm x 10.3 mm x 7.88 mm	1 200 000
	ø6.6 mm x 19 mm	800 000

- ▶ Tilt Angle: 35°
- ▶ Max throughput rates are related to the shape and the size of the tablets / capsules

DUST TIGHT & WASH-IN-PLACE METAL DETECTION SYSTEMS



THS/PH21[®]N-DT

DUST TIGHT METAL DETECTION SYSTEM

Dust tight transit pipe and ejection system prevents dispersion of the product

- Transit tunnel and ejection system completely sealed (OEB 5 certified)
- Easy integration with tablet press and deduster from the leading manufacturers
- Rapid maintenance does not require the employment of tools to assemble and disassemble the components
- AUTOTEST function
- AUTO-QC function



THS/PH21[®]N-WIP

WASH-IN-PLACE METAL DETECTION SYSTEM

A special built-in washing system allows complete cleaning of the conduits after completion of each production batch

- Transit tunnel and ejection system completely sealed (OEB 5 certified)
- Fitted with nozzles for washing water injection and decontamination
- Easy integration with tablet press and deduster from the leading manufacturers
- Antistatic, Jamming Sensor and Bin full Kits (available on demand)
- AUTOTEST function
- AUTO-QC function



INTEGRATED SYSTEMS

NEW

THS/PH210®-FFV

FOR **GRANULAR AND POWDER PRODUCTS**

- THS/PH210 Series Technology
- Extremely high performances: +50% sensitivity in terms of detectable metal volume
- High visibility HMI with large (7") colour display and extremely robust capacitive touch screen
- Easy valve assembly and disassembly without tools.
- Hygienic design criteria
- Automatic compressed air monitoring
- Real time monitoring of the valve position
- ATEX ZONE 22 version (available on demand) 
- AUTOTEST function
- AUTO-QC function



THS/PH21®N-FFV

FOR **GRANULAR AND POWDER PRODUCTS**

- Ultra High Sensitivity to all metals
- Very compact size
- AISI 316L stainless steel construction
- Control Power Box available according to UL 508A and CSA-C22.2 No. 286
- ATEX ZONE 21 version (available on demand) 
- AUTOTEST function
- AUTO-QC function



THS/PLV 21 SERIES

FOR **LIQUID AND VISCOUS PRODUCTS**

- Wide range of standard pipe sizes available to suit all applications
- Full compliance with HACCP criteria
- AISI 316L stainless steel construction
- Fast acting reject device for a limited quantity of rejected product
- Easy to clean and inspect
- AUTOTEST function
- AUTO-QC function



CONVEYOR INSPECTION SYSTEMS

THS/FBB THS/MBB

FLAT AND MODULAR CONVEYOR INSPECTION SYSTEMS

- High Sensitivity to all metals
- Integrated controls for line speed and rejection
- High immunity to environmental interference
- Automatic learning & tracking of product effect
- AUTOTEST function
- AUTO-QC function
- Easy to maintain and inspect
- Digitally adjustable belt speed
- Control Power Box available according to UL 508A and CSA-C22.2 No. 286 
- Applications:
 - ✓ Flacons ✓ Bottles ✓ Packaging
 - ✓ Loose product



THS/PH21N-FB

DETECTION OF VERY TINY METAL PARTICLES ON EFFERVESCENT TABLETS WITH AUTOMATIC REJECTION

- Ultra high sensitivity to all magnetic and non-magnetic metals, including stainless steel
- AISI 316L stainless steel construction
- Integrated controls for line speed and rejection
- High immunity to environmental interference
- Automatic learning & tracking of product effect
- AUTOTEST function
- AUTO-QC function
- Easy to maintain and inspect
- Digitally adjustable belt speed
- Automatic ejection management with synchronization of the product transit
- Verification of the successful ejection of the contaminated product

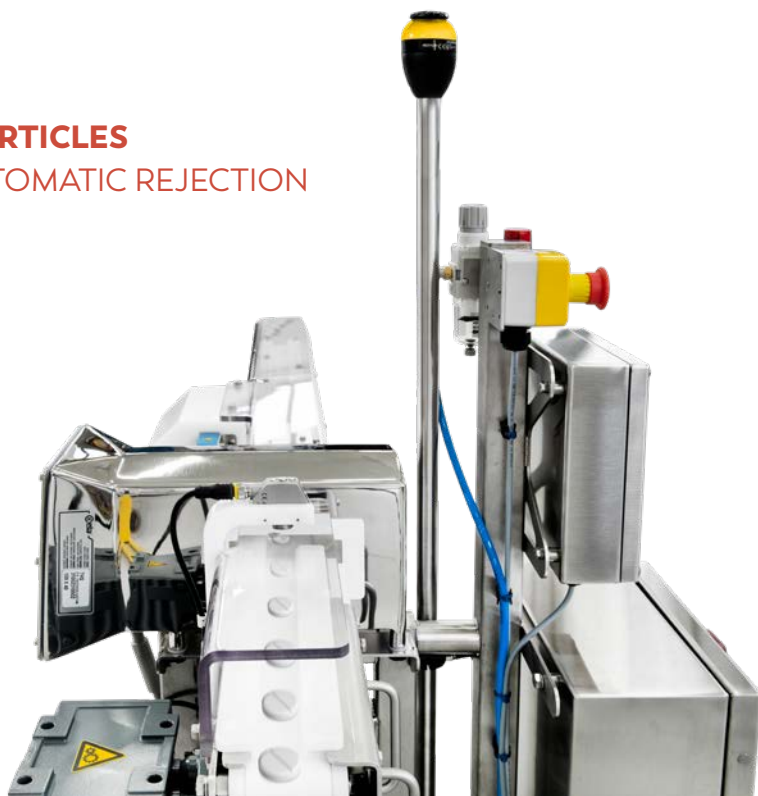

HIGH PERFORMANCE INSPECTION AGAINST TINY METAL PARTICLE CONTAMINATION

THS/PH21N-D25

ULTRA HIGH SENSITIVITY METAL DETECTOR

- Unsurpassed Detection
- Best Product Quality
- Round aperture
- AUTOTEST function
- AUTO-QC function
- Automatic Calibration Test
- Applications:
 - ✓ R&D analysis
 - ✓ Rework confirmation
 - ✓ Root cause analysis assistance
 - ✓ New product specification

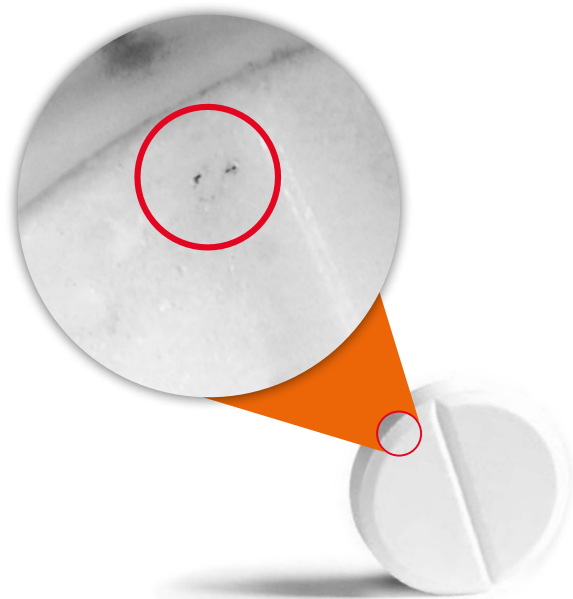

EXAMPLE OF THROUGHPUT

PRODUCT		VERIFIED THROUGHPUT (items / h)
	Diameter: Ø 8,5 mm Thickness: 4,5 mm	30,000

WORKING PARAMETERS

- ✓ Tilt Angle: 35°
- ✓ Max Throughput Rates are related to the shape and to the size of the tablets



THS PRODUCTION 4.0 ENABLING INDUSTRY 4.0

SMART FACTORY

- ✓ CEIA-ERP API interface for communication to the factory management software (Microsoft Dynamics NAV, SAP, ORACLE ERP)
- ✓ OPC-UA protocol API for Metal Detector Monitor and Control
- ✓ Connection to an External Database and Definition of a Programmable Block of SQL Instructions for each Metal Detector Event
- ✓ Compatible with standard SCADA Systems
- ✓ E-mail sender for Metal Detector events
- ✓ Integrated Web-Server Appliance for real-time monitoring for HMI and touch panel

PREDICTIVE MAINTENANCE

- ✓ Data Inspector Tool for signal and production analysis (enhanced option)
- ✓ Early Metal Explosion identification
- ✓ Batch management for defective product traceability



THS PRODUCTION 4.0 HIGHLIGHTS

- ✓ Connects and Acquires Data from Multiple THS Detectors via wired or wireless LAN (requires IXC module for the THS/PH21 series)
- ✓ Enables Data Base Management and Back-Up of Metal Detector events
- ✓ Report Data Exportable in HTML, CSV and PDF formats
- ✓ Provides User Authentication and Manages Electronic Signatures and Records
- ✓ Allows Data Integrity and Operator Auditing
- ✓ FDA Requirements Compliant, Title 21 of the Code of Federal Regulations (CFR)
- ✓ High performance 64-bit database that handles more than 500 millions events

CEIA-ERP INTERFACE FOR COMMUNICATION

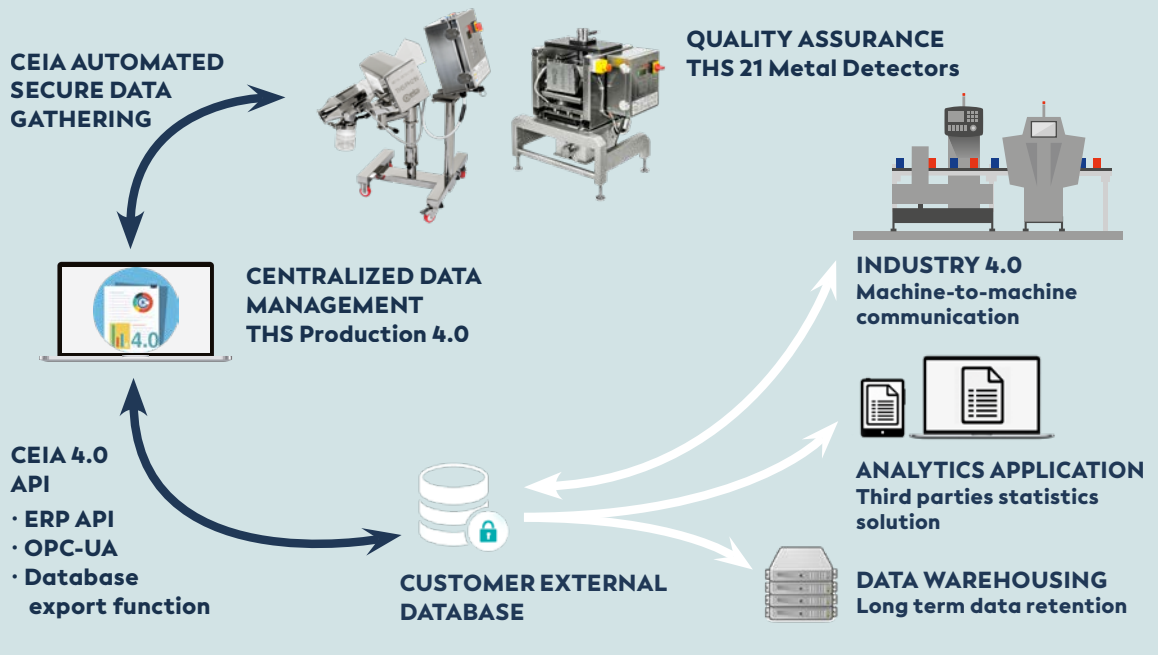

SOPHISTICATED INTERFACE CAPABILITIES

NETWORK COMMUNICATION

The Metal Detector can be linked to an Ethernet network (optional IXC module required for THS/PH21 series).

In association with the THS Production 4.0 Software it enables remote management of production, collection of all technical and operational events, generation of statistical and traceability reports in compliance with FDA 21 CFR part 11 requirements.

BT CONNECTIVITY

In the THS/21 Series, local connection to the maintenance technician's computer no longer requires physical access to the interior of the detector or the use of unwieldy connection cables.

The BT connection can be used for programming, monitoring of the signals via the CEIA MD-Scope program and the transfer of the data contained in the Metal Detector's events memory.

MD-SCOPE SOFTWARE

Software Diagnostic Package complete with connector cable and hardware key:

- REMOTE PROGRAMMING
- INPUT/OUTPUT SIGNALS
- DETECTED AND ALARM SIGNALS
- OSCILLOSCOPE FUNCTIONALITIES

EXAMPLE OF SIGNAL DURING TEST

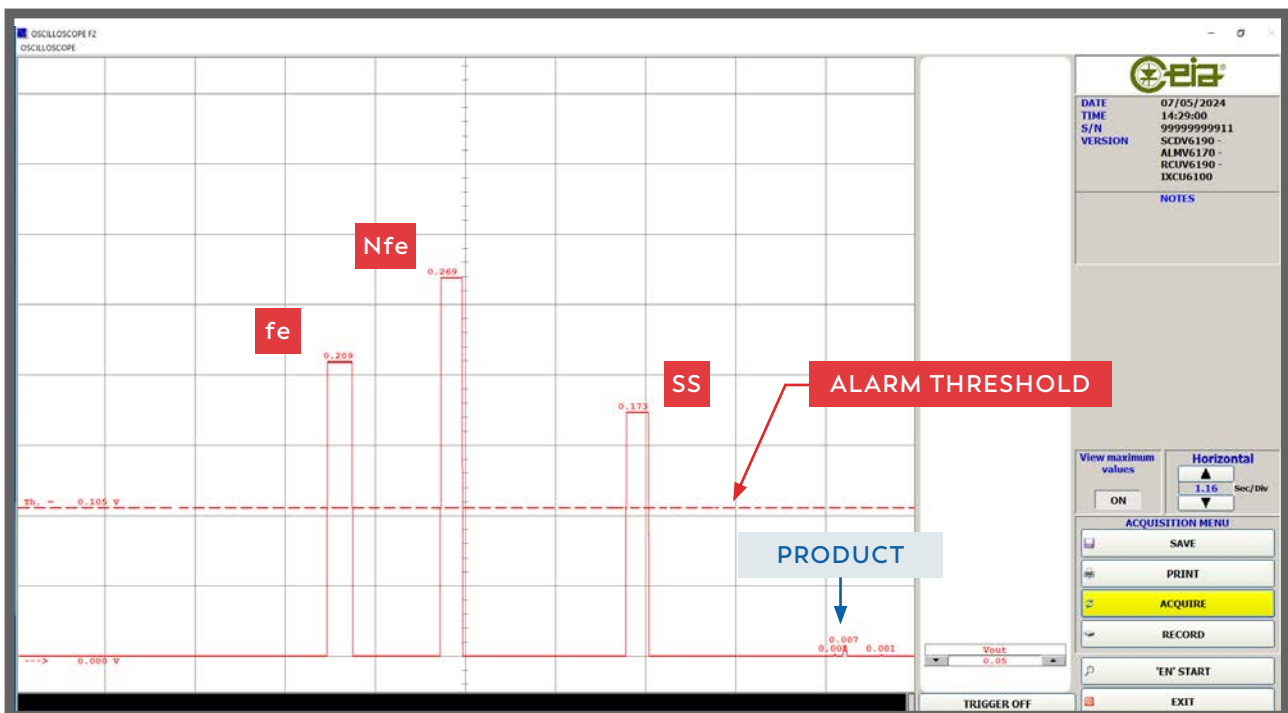

ADVANCED CONNECTIVITY

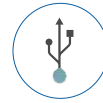
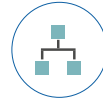





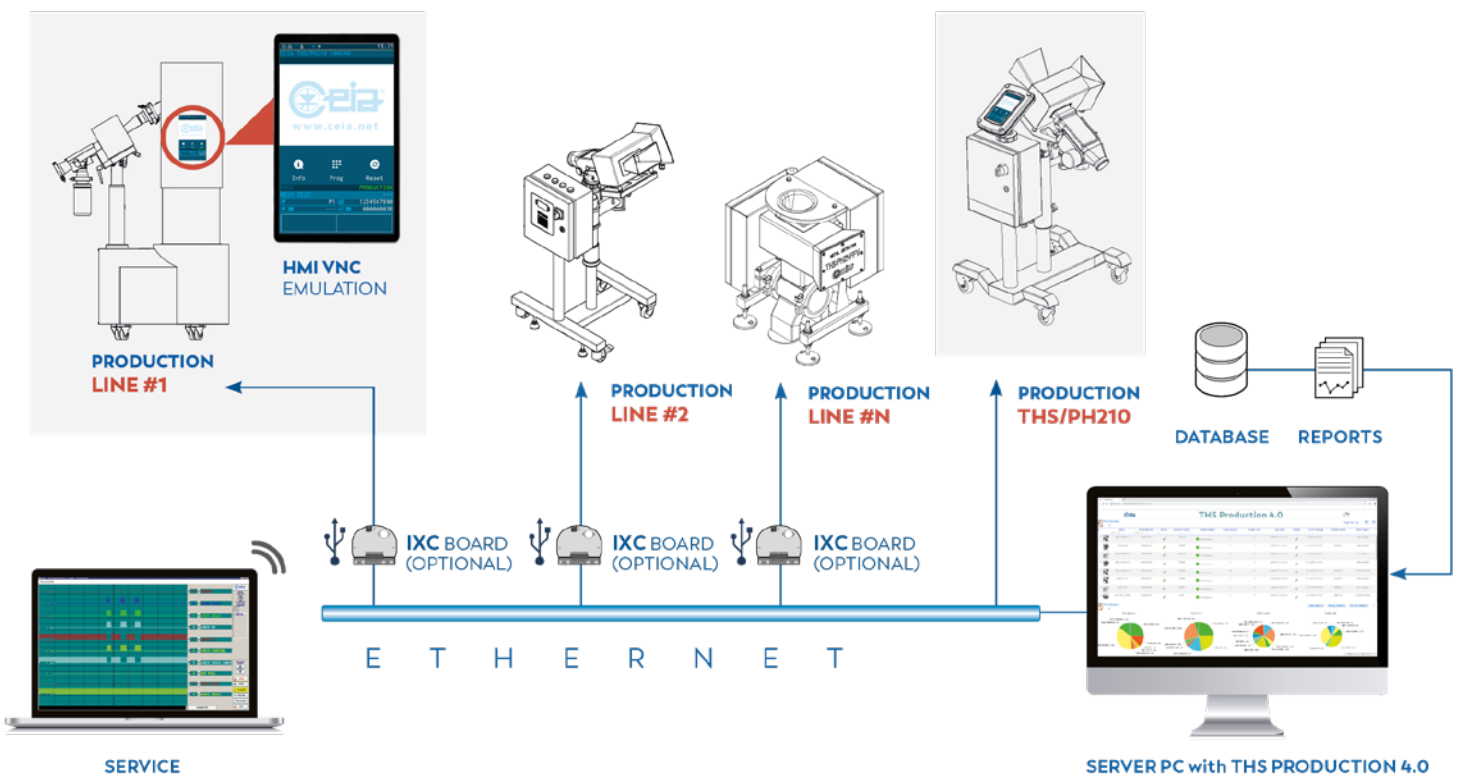

INTERFACES	THS/PH21ET - THS/PH21N	THS/PH210
BT WIRELESS	●	●
ETHERNET WITH WEB SERVER	○ with IXC BOARD	●
USB	○ with IXC BOARD	●
HMI emulation by VNC client	○ with IXC BOARD	●
EtherNet/IP	○ with IXC BOARD	●
Profinet Profibus EtherCAT Modbus-TPC Profinet-OPC-UA	—	○

● STANDARD ○ OPTIONAL



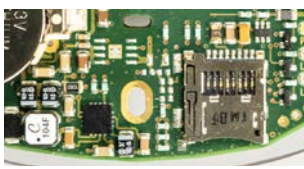







OPTIONS

PART	DESCRIPTION	APPLICABLE MODELS
	<p>IXC CARD WITH INTERNAL USB KEY</p> <p>Additional card that provides the detector a network Interface, (Ethernet or WiFi), integrated Webserver and a USB interface to save or load data relevant to the products, configuration, and events. This option also includes internal memory up to 100,000 events.</p>	<ul style="list-style-type: none"> • THS/PH21N • THS/PH21ET • THS/PH21N-D25 • THS/PH21N-FFV • THS/PH21ET-FFV
	<p>EXTERNAL USB PLUG KIT</p> <p>Allows USB connector of the IXC card to be mounted outside of the Power Control Box.</p>	<ul style="list-style-type: none"> • THS/PH21N • THS/PH21ET • THS/PH21N-D25 • THS/PH21N-FFV • THS/PH21ET-FFV
	<p>EtherNet/IP FIELD BUS FUNCTION</p>	<ul style="list-style-type: none"> • THS/PH21N • THS/PH21ET • THS/PH21N-D25 • THS/PH21N-FFV • THS/PH21ET-FFV
	<p>FIELD BUS FUNCTION</p> <ul style="list-style-type: none"> • Ethernet/IP • Profinet • Profibus • EtherCAT • Modbus-TPC • Profinet-OPC-UA • Ethernet/P-OPC-UA 	<ul style="list-style-type: none"> • THS/PH210
	<p>ANTISTATIC INFEEED CONVEYOR KIT</p> <p>Eliminates electrostatic charges during the product's passage. Particularly efficient in case of tablets and capsules' inspection.</p>	<ul style="list-style-type: none"> • THS/PH21N • THS/PH21ET
	<p>ANTISTATIC INFEEED CONVEYOR KIT FOR DUST TIGHT (DT) VERSION</p> <p>Dust Tight Infeed conveyor eliminates electrostatic charges during the product's passage. Particularly efficient in case of tablets and capsules' inspection.</p>	<ul style="list-style-type: none"> • THS/PH21N • THS/PH21ET
	<p>ANTISTATIC INFEEED CONVEYOR KIT FOR WASH IN PLACE (WIP) VERSION</p> <p>Wash In Place Infeed Conveyor with nozzles eliminates electrostatic charges during the product's passage. Particularly efficient in case of tablets and capsules' inspection</p>	<ul style="list-style-type: none"> • THS/PH21N • THS/PH21ET

OPTIONS



PART	DESCRIPTION	APPLICABLE MODELS
	<p>ANTISTATIC KIT</p> <p>Infeed chute kit eliminates electrostatic charges during the product's passage. Particularly efficient for powder and granular inspection.</p>	<ul style="list-style-type: none"> • THS/PH21N-FFV • THS/PH21ET-FFV
	<p>INFEEED JAM SENSOR</p> <p>Added sensor installed between the infeed conveyor and the probe. Provides alarm message in case of product jamming.</p>	<ul style="list-style-type: none"> • THS/PH21N-D25
	<p>JAM SENSOR</p> <p>Added sensor installed between the probe and the ejection carter. Provides alarm message in case of product jamming.</p>	<ul style="list-style-type: none"> • THS/PH21N-FFV • THS/PH21ET-FFV
	<p>TSDU (TEST SAMPLE DISTRIBUTOR UNIT)</p> <p>When installed to a THS/PH21 Metal Detector equipped with double reject, it allows a safe mode test with no interference to product flow. 9 test samples per unit are included in the price (3 of each type: Ferrous, Non Ferrous and Stainless AISI316)</p>	<ul style="list-style-type: none"> • THS/PH21N • THS/PH21ET
	<p>BIN FULL SENSOR KIT</p>	<ul style="list-style-type: none"> • THS/PH210
	<p>BIN FULL SENSOR</p> <p>Added sensor that activates when the reject bin is full with rejected products. When activated, an alarm message on the detector's display warns the operator of the full condition.</p>	<ul style="list-style-type: none"> • THS/PH21N • THS/PH21N-D25 • THS/PH21ET
	<p>TEST SAMPLES</p> <p>Fe Non Fe AISI 316</p>	<ul style="list-style-type: none"> • THS/PH210 • THS/PH21N • THS/PH21ET • THS/PH21N-D25 • THS/PH21N-FFV • THS/PH21ET-FFV





ACCESSORIES



PART	DESCRIPTION	APPLICABLE MODELS
	<p>REJECTED PRODUCT CONTAINERS</p> <p>500 ml - PH210 950 ml - PH210</p>	<ul style="list-style-type: none"> • THS/PH210
	<p>REJECTED PRODUCT CONTAINERS</p> <p>500 ml - STANDARD 950 ml - STANDARD</p>	<ul style="list-style-type: none"> • THS/PH21N • THS/PH21ET • THS/PH21N-D25
	<p>REJECTED PRODUCT CONTAINERS</p> <p>500 ml - TRICLAMP/DT/WIP 950 ml - TRICLAMP/DT/WIP</p>	<ul style="list-style-type: none"> • THS/PH210-DT • THS/PH210-WIP • THS/PH21N • THS/PH21ET • THS/PH21N-D25
	<p>PERIODIC MAINTENANCE KIT</p> <p>Kit includes:</p> <ol style="list-style-type: none"> 1. One (1) lift flap bearing support 2. One (1) Infeed Conveyor 3. One (1) Intermediate Conveyor 	<ul style="list-style-type: none"> • THS/PH21N • THS/PH21ET
	<p>PERIODIC MAINTENANCE KIT</p> <p>Kit includes:</p> <ol style="list-style-type: none"> 1. One (1) lift flap bearing support 2. One (1) Infeed Conveyor 3. One (1) Intermediate Conveyor 	<ul style="list-style-type: none"> • THS/PH210
	<p>PERIODIC MAINTENANCE KIT</p> <p>Kit includes:</p> <ol style="list-style-type: none"> 1. One (1) rejector Valve Bushing 2. One (1) Infeed Conveyor 3. One (1) Infeed Valve O-ring 	<ul style="list-style-type: none"> • THS/PH21N-FFV • THS/PH21ET-FFV
	<p>PERIODIC MAINTENANCE KIT</p> <p>Kit includes:</p> <ol style="list-style-type: none"> 1. One (1) lift flap bearing support 2. One (1) Infeed Conveyor 3. One (1) Intermediate Conveyor 	<ul style="list-style-type: none"> • THS/PH21N-D25

ACCESSORIES

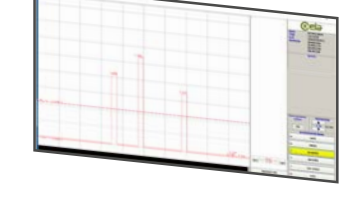
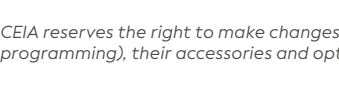

PART	DESCRIPTION	APPLICABLE MODELS
	<p>VALIDATION MANUAL</p> <p>Detailed hardcopy document for process/ equipment validation of detector.</p>	<ul style="list-style-type: none"> • THS/PH210 • THS/PH21N • THS/PH21ET • THS/PH21N-D25 <hr/> <ul style="list-style-type: none"> • THS/PH21N-FFV • THS/PH21ET-FFV
	<p>VALIDATION MANUAL (DIGITAL DOCUMENT)</p> <p>Detailed electronic document that can be downloaded through a link provided by CEIA for process/ equipment validation of detector.</p>	<ul style="list-style-type: none"> • THS/PH210 • THS/PH21N • THS/PH21ET • THS/PH21N-D25 <hr/> <ul style="list-style-type: none"> • THS/PH21N-FFV • THS/PH21ET-FFV
	<p>TECHNICAL MANUAL</p> <p>Detailed hardcopy document(s) that includes:</p> <ol style="list-style-type: none"> 1. Installation Manual 2. Operator Manual 3. Programming Manual 	<ul style="list-style-type: none"> • THS/PH210 • THS/PH21N • THS/PH21ET • THS/PH21N-D25 • THS/PH21N-FFV • THS/PH21ET-FFV
	<p>TECHNICAL MANUAL (DIGITAL DOCUMENT)</p> <p>Detailed electronic document(s) that can be downloaded through a link provided by CEIA.</p> <p>Package includes: 1. Installation Manual 2. Operator Manual 3. Programming Manual</p>	<ul style="list-style-type: none"> • THS/PH210 • THS/PH21N • THS/PH21ET • THS/PH21N-D25 • THS/PH21N-FFV • THS/PH21ET-FFV
	<p>THS PRODUCTION 4.0</p> <p>Software for the data management (see page 11). Requires installation of IXC option.</p>	<ul style="list-style-type: none"> • THS/PH210 • THS/PH21N • THS/PH21ET • THS/PH21N-D25 • THS/PH21N-FFV • THS/PH21ET-FFV
	<p>MD-SCOPE</p> <p>Software diagnostic tool (that can be installed on the user's PC). Allows remote programming, signal input/output, review/analysis of alarms and amplitude of signal(s), and oscilloscope functionalities. Includes software, connector cable and a USB key.</p>	<ul style="list-style-type: none"> • THS/PH210 • THS/PH21N • THS/PH21ET • THS/PH21N-D25 • THS/PH21N-FFV • THS/PH21ET-FFV

THS/PH21® MECHANICAL DATA

THS/PH21N • THS/PH21WIP • THS/PH21DT

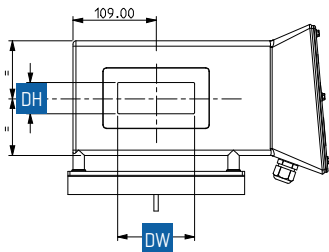

APERTURE SIZE [DW x DH]

90 x 25

100 x 40

THS/PH21N-D25

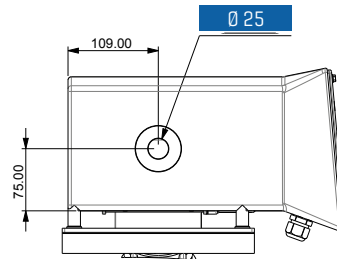

APERTURE SIZE

Ø 25

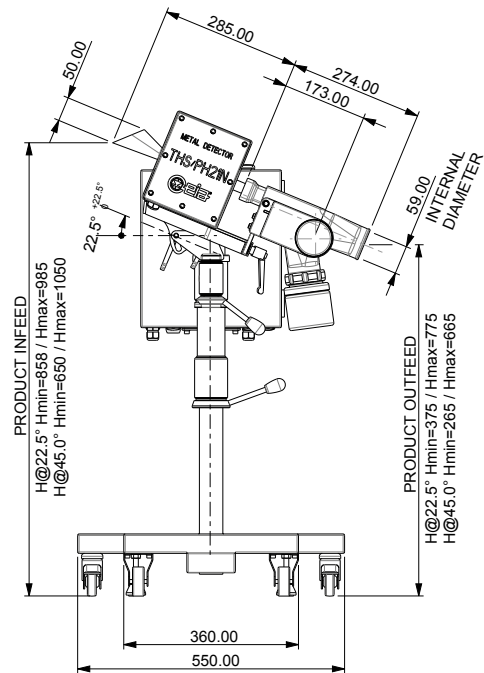
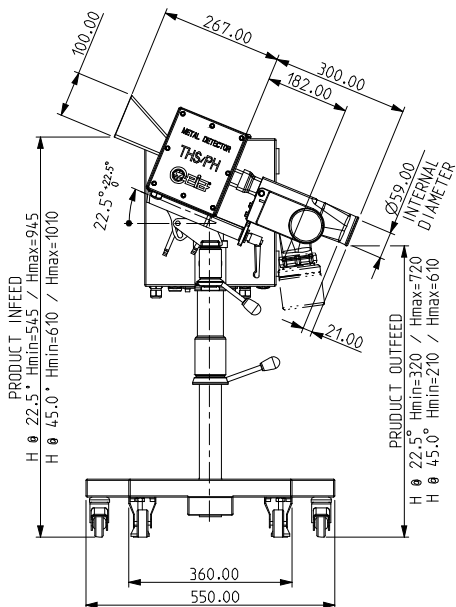

THS/PH21N-FFV • THS/PH21E-FFV

APERTURE SIZE	A	B
100 x 40	90	30
90 x 25	78	13

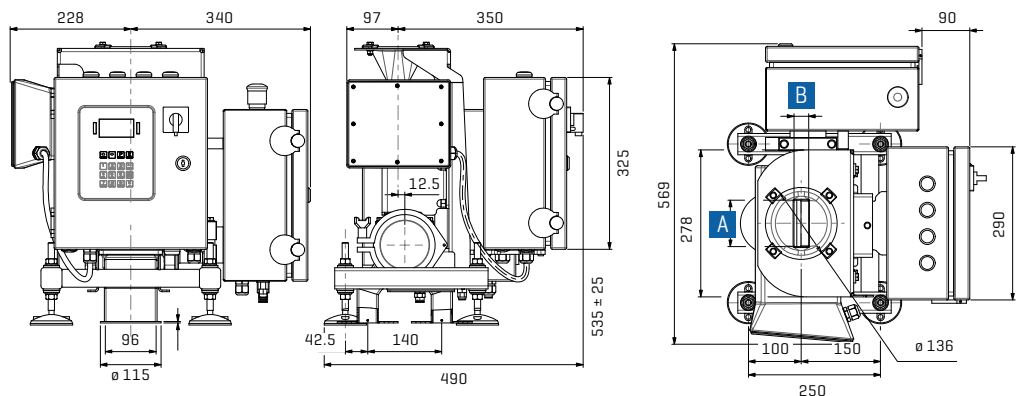

Dimensions in mm

THS/PH210[®] MECHANICAL DATA

THS/PH210

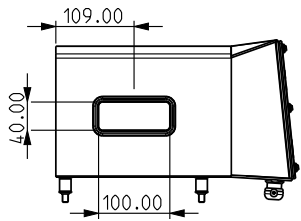
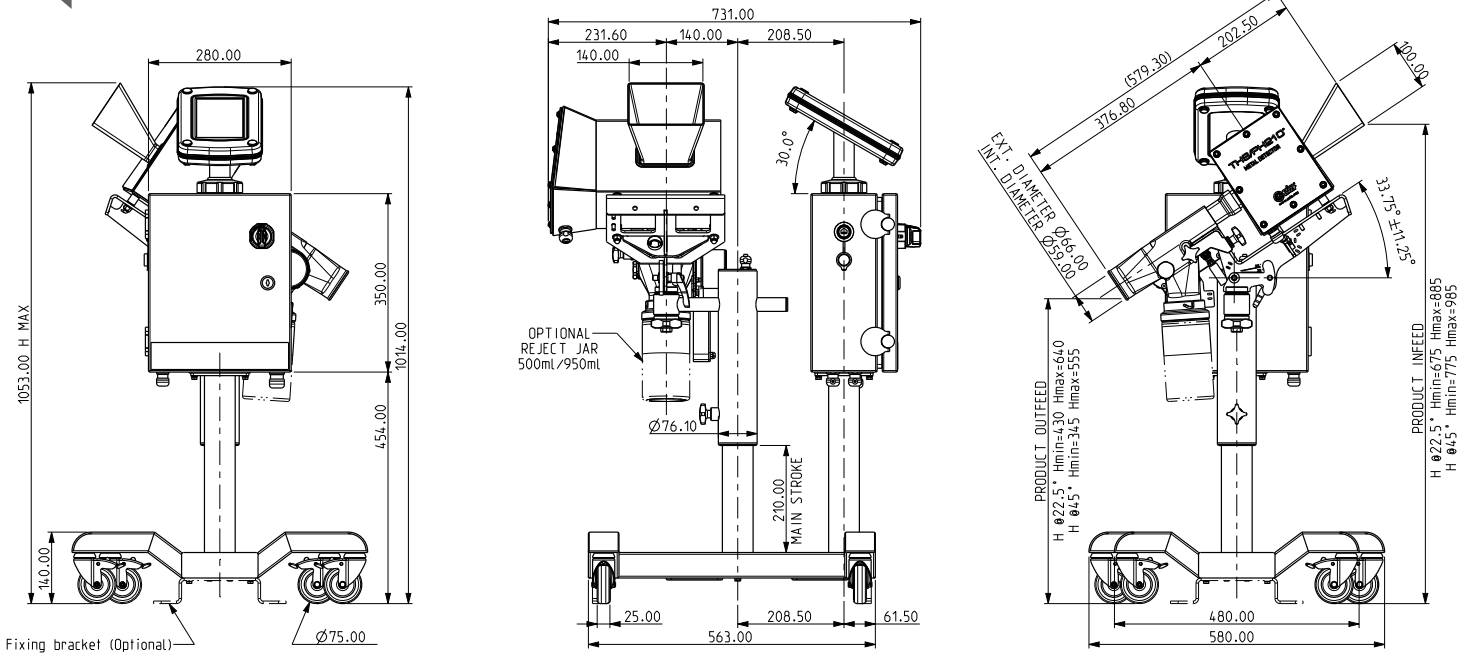

APERTURE SIZE

100 x 40

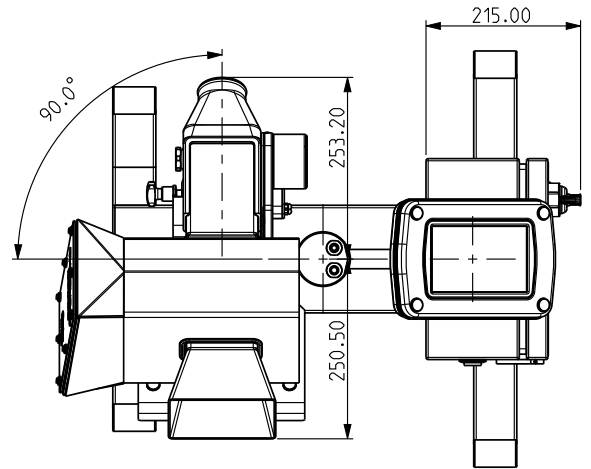
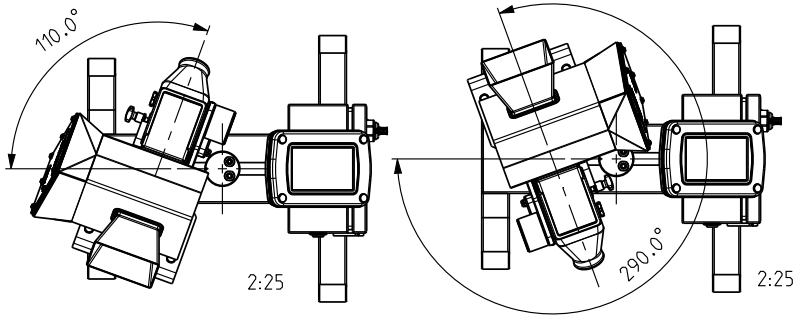

Dimensions in mm



CEIA THS/PH21°N

CEIA - Zona Industriale 54, 52041 Vicinaggio - Arezzo (ITALY)

☎ +39 0575 4181 • ✉ qa-detectors@ceia-spa.com



www.ceia.net



CEIA reserves the right to make changes, at any moment and without notice, to the models (including programming), their accessories and options, to the prices and conditions of sale. DP002K0033v1000hUK - 2024